

Product Specification

Timestrip®PLUS 25°C 12Hours TP-217

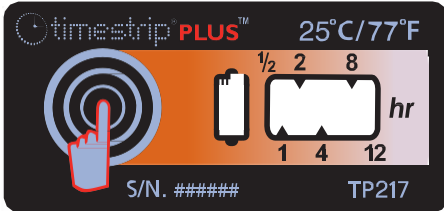

General:

Each Timestrip®PLUS indicator is a small, self-adhesive label that can be attached to a product, package or carrying card*. It monitors temperature and indicates when a maximum threshold has been breached. It is irreversible and also records the total time duration of one or more breaches.

* see adhesive specification in Appendix 1 below for further details.

Each product in the range has been engineered for a different maximum threshold temperature so customers can choose the Timestrip®PLUS that best suits their needs.

How to use:

Timestrip®PLUS indicators are completely inert prior to activation and can be stored at room temperature.

To activate Timestrip®PLUS, the surrounding temperature must be above the stated threshold temperature so that the blue dyed liquid can be released from the button. Fully squeeze the button and check that the first window turns blue and the word 'On' appears. If not, immediately re-squeeze the button fully. Within 2-3 minutes of activation, place the indicator below its STOP temperature for a minimum of 1 Hour so that the liquid freezes and the indicator is fully conditioned and ready to use. If the carrying card or the product to be monitored is already at or below the STOP temperature then the indicator can be stuck directly to it by removing the adhesive liner on the back.

| Threshold Temp | Stop temp* | Run-Out window** | Time Marks in Hours |
|----------------|------------|------------------|----------------------|
| +25°C/+77°F | 22°C/+72°F | 12 Hours | 1/2, 1, 2, 4, 8 & 12 |

* The temp at which the run-time advancement

(the movement of the blue dye) will stop.

** The run-out window is calibrated to an isothermal temp of +2°C deg above the stated/printed Threshold temp.

I) Performance Specifications:

- ‡ Temp Accuracy: ± 1°C/2°F
- ‡ Time Accuracy: ± 15 % in time under isothermal conditions
- ‡ Progress Isotherms: See Fig. 1
- ‡ Display: Continuous, irreversible
- ‡ Usage: The usage of the product in any assembly or production line must be agreed upon in advance, as it may alter performance specifications.

II) Product Specification:

- ‡ Button Position: Button on Top (BOT)
- ‡ Colour of Progressing Front: Blue
- ‡ Adhesive: #2641, Pressure sensitive, -40°C to +110°C, Finger lift – See Appendix 1
- ‡ Product drawing: See Fig. 2
- ‡ Graphics: See Fig. 3
- ‡ Other: Not suitable for immersion in water
- ‡ Remark: Run-time window length will vary slightly between production batches.

III) Product Construction:

The indicator is constructed of polymeric assembly multilayer and aluminium-plastic laminate. It encapsulates coloured liquid chemicals*.

* Maximum weight of colorant is <0.5 mg.

** Liquid chemicals are listed in the Food Chemicals Codex and/or approved by the Food and Drug Administration (FDA) under Title 21, and/or considered generally recognized as safe (GRAS).

*** All materials are non-toxic, latex and PVC free.



the smart way to measure time & temperature



IV) Storage Conditions (un-activated):

- ‡ Store in a cool dark environment away from heat sources.
- ‡ Recommended: 22°C/72°F at 20-80% RH.
- ‡ Please note that before activation, the product can tolerate short term exposure. during transit (hours or a few days) to temperatures in the range -30°C to +55°C. However, long term storage should be under recommended conditions.

V) Shelf-life:

- 2 Years – an expiry date is stated on each pack.

Fig 1: Progress Isotherm

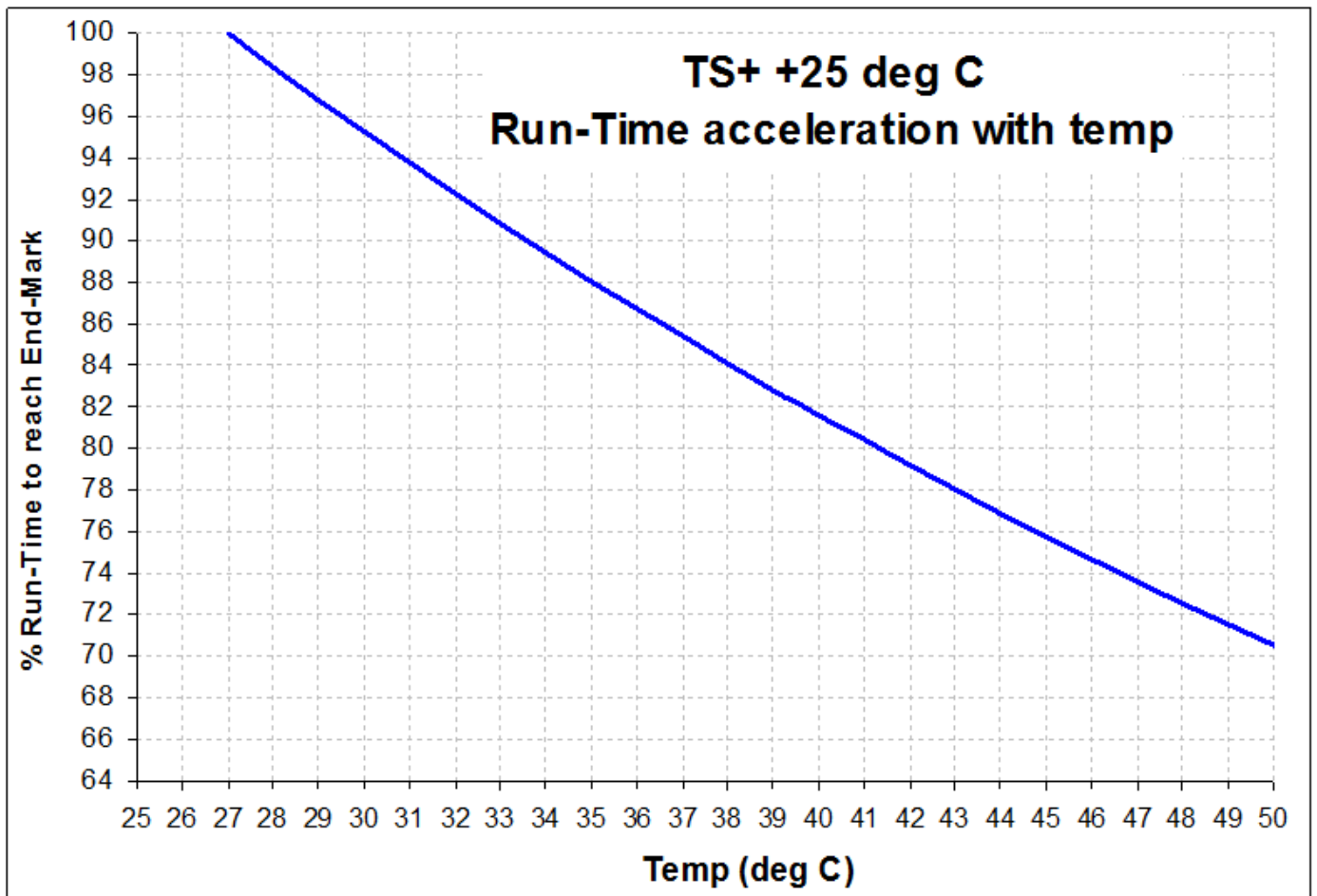

Fig 2: Product Drawing

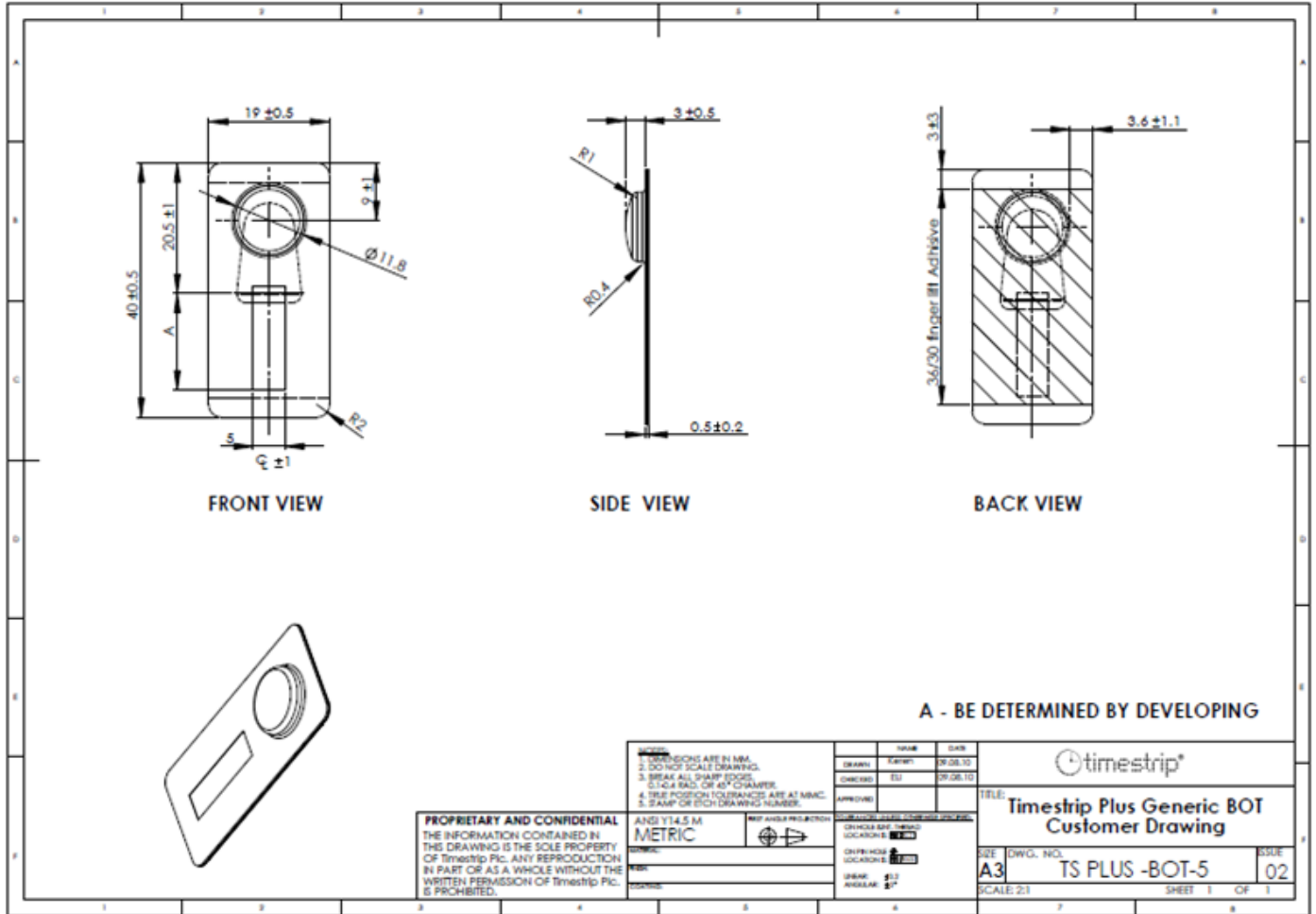



Fig 3: Graphics

Before...



100%



200%

| | |
|--|--------------|
| | P536 ec |
| | 70m 100y 10k |
| | black |
| | P485 ec |
| | 1c 11m 10k |

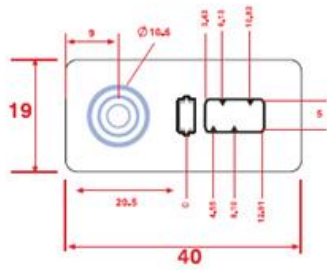

***For Approval:**

1. Print out, sign and Fax to + 972-9-8991347
- or
2. Send a Mail with the approved graphics attached to mail.

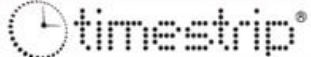
| | | | |
|----------------------------|--|---|-------------|
| Customer approval * | |  | |
| Name | | Title: 12 Hours 25c TSP TimestripPlusLine BOT | |
| Sign. | Graphic Designer: Ola F. 09.10.13 Lin. Tolerance: ±0.5mm. | Graphic no. | Rev. 1 |
| Date | Drawing No.: Printing DWG: | 800-217A | SH. 1 OF. 1 |

Appendix 1

Pressure Sensitive Adhesive Data

Timestrip Adhesive - Product # 2641

| | <u>SUBSTANCE</u> | | <u>THICKNESS</u> |
|----------|------------------|--------------------|------------------|
| Adhesive | 40gsm | Adhesive & Carrier | 95 micron |
| Tissue | 12gsm | | |
| Adhesive | 45gsm | | |
| Liner | 80gsm | Liner | 70 micron |

PRODUCT DESCRIPTION

A permanent tape with a tissue carrier. The adhesive is a modified acrylic, offering good UV light and chemical resistance together with high performance especially to difficult surfaces. The liner is a two side release system.

APPLICATIONS

The high tack/adhesion of 2641 makes it especially useful for applications involving the bonding of difficult substrates such as many foams, rubbers and polythene type materials. The product is also useful for various mounting applications.

ADHESIVE PROPERTIES

| | | <u>20 min</u> | <u>24 hour</u> | <u>TEST METHOD</u> |
|--------------------------------|-------------|---------------|----------------|--------------------|
| Adhesion to steel | open side | 1300 N/M | 1400 N/M | BS7116:1990 - D |
| | closed side | 1300 N/M | 1400 N/M | BS7116:1990 - D |
| Shear Adhesion | open side | 5 hours | | BS7116:1990 - B |
| | closed side | 5 hours | | BS7116:1990 - B |
| Release of liner from adhesive | | 10 N/M | | BS7116:1990 - E |

THERMAL PROPERTIES

| | | |
|---------------------------------------|----------------|----------------|
| Recommended service temperature range | -40°C to 110°C | -40°F to 230°F |
| Application temperature range | 5°C to 60°C | 41°F to 140°F |

SHELF LIFE

Minimum shelf life when stored in closed cartons away from direct sources of heat and sunlight. 2 Years

HEALTH AND SAFETY INFORMATION

The adhesive conforms to F&DA Regulation 175.105.

Note

Values given are average and should not be taken as a maximum or minimum for specification purposes. Specific technical details, applications information and suggested uses available.

For additional information contact us on:

1, Haatzmut Street, P.O. box 3005, Even Yehuda, 40500, Israel
Tel: +972-9-8992005 Fax: +972-9-8991347

QA-AD1 12/09

Document information

| Document Type | Identifying No. | Rev./Issue | Date |
|-----------------------------|-----------------|------------|----------|
| Graphics | 800-217A | 01 | 09.10.13 |
| Product Drawing | TS PLUS-BOT-5 | 02 | 09.08.10 |
| Adhesive #2641 Data Sheet | QA-AD1 | 00 | 12/2009 |
| Product Specification Sheet | -- | 00 | 22.07.14 |